

# Stainless steel pull out faucet installation manual

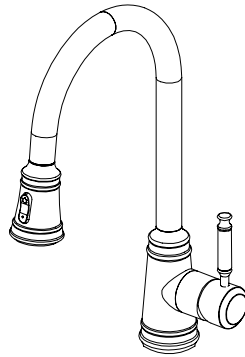

Pull out faucet exploded drawing

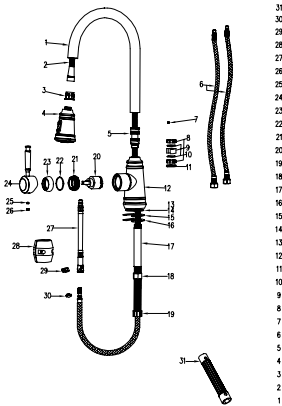

Packing layout

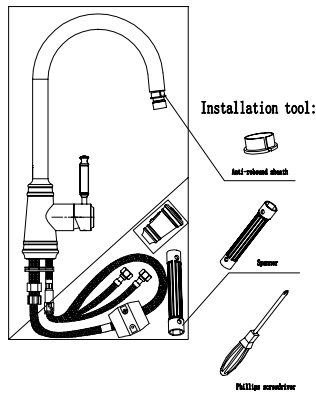

Part Drawing for Product Selection

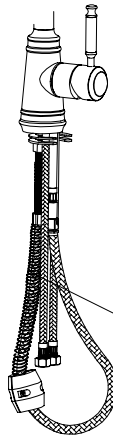

Pull booster spring

(Note: If your pull faucet is empty under the platform it can be selected if it is narrow or interferes with the drawing space. Choose to install this part to enhance sprinkler automatic rebound. Performance. If your cabinet has enough space for drawing, it is not recommended to install this accessory.)

Step 4: Undercounter installation

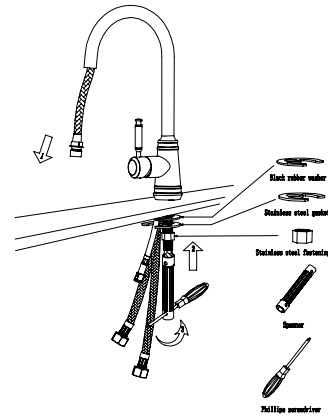

Step 5: Undercounter installation

(Attention: When installing the gravity ball, please install the gravity ball in the drawing pipe. It is recommended to install the logo below.)

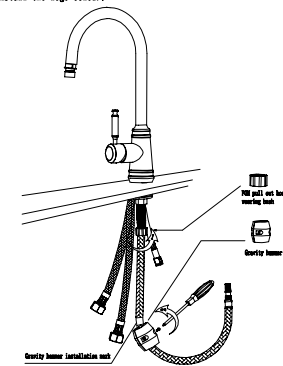

Step 6: Undercounter installation

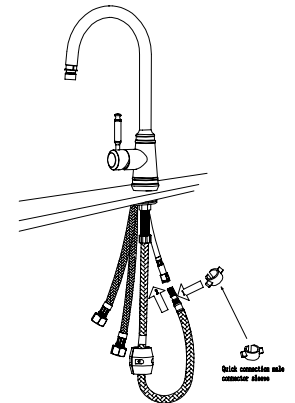

Step 7: Undercounter installation

(Attention: the quick connector must be secured before clip into the white clip)

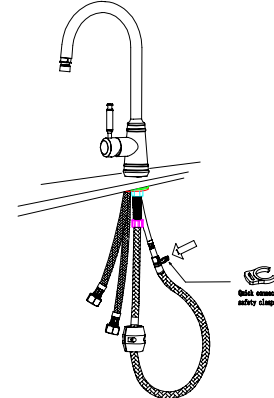

Step 8: Installation for Hot&Cold inlet hoses

(Attention: please do not entangle with the pull out hose, make room for the pull out hose)

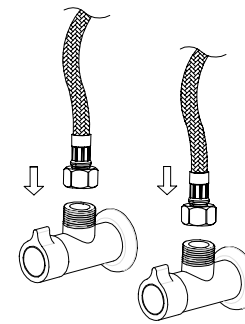

Step 9: Turn on the faucet, rinse the pipe for impurities

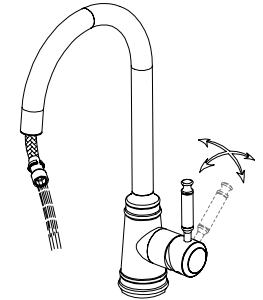

Step 1: Take out the product from the box

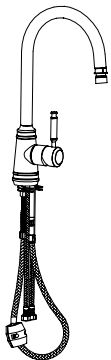

Step 2: Disassemble the parts

(Attention: please do not disassemble the Hot&Cold inlet hose and Mixed water inlet hose)

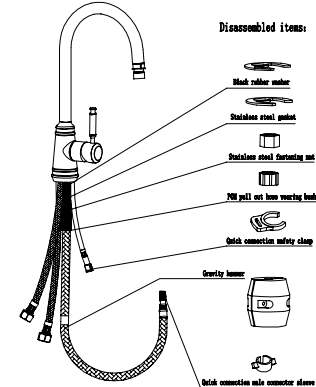

Step 3: Pull the faucet on the countertop

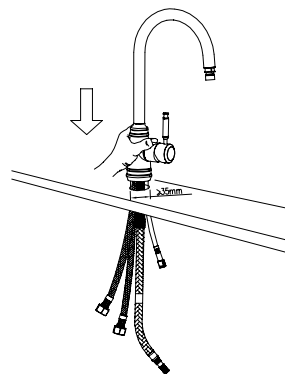

Step 10: Twist the spayer and hose tightly

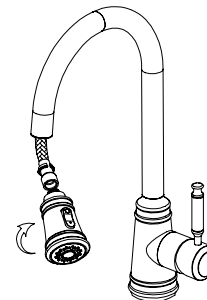

Step 11: Remove the shower holder and keep it well

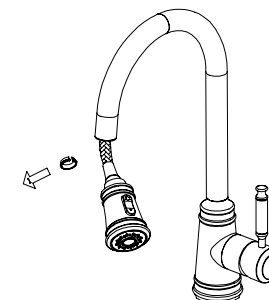

Step 12: Finished

